



**ALUMINIUM GATES
WALES**



ALUMINIUM GATES

ALUMINIUM GATES

Our expertly designed standard gates are crafted to complement any home and garden seamlessly.

Custom-Made Solutions & Bespoke Finishes

We specialise in crafting custom-made gates, offering you specific width modifications and the option to request bespoke RAL colours for a personalised touch.

Why Choose Aluminium Gates?

Aluminium gates are renowned for their strength, durability, and corrosion resistance. As a premium and sustainable product, aluminium is infinitely recyclable and environmentally friendly, requiring minimal maintenance. A simple wipe-down with soapy water and a microfibre cloth keeps them looking pristine for years.

Fast Delivery & Nationwide Coverage

AGD001DG

Aluminium Driveway Gate, flat top, fully boarded vertical solid infill, providing full privacy, with a contemporary, modern aesthetic.



DOUBLE SWING DRIVEWAY GATE

Design:	Flat Top, Full Privacy, with Vertical Solid Infill
Material:	Aluminium
Opening Direction:	Universal (orientation is set when installing)
Supplied with gate as std:	4 x Adjustable wall mounted hinges, 2 x Floor mounted hinges
Finish:	Powder-coated, textured finish
Std Gate Colours:	Jet Black and Anthracite Grey
Aluminium	Available as an additional extra.
Posts & Caps:	150mm/150mm /2400mm and 150mm/150mm/3000mm
Build:	Fully assembled weather resistant gate

Lock for Manual Operation:	Sold separately and factory installed
Bespoke:	Gate widths and gate colours are available
Warranty:	Five-year manufacturer's guarantee

CUSTOMISABLE AS A SLIDING GATE

COLOUR AVAILABILITY

- **Jet Black** - RAL 9005
- **Anthracite Grey** - RAL 7016
- **Bespoke Colour**

AGD001DG

Aluminium Driveway Gate, flat top, fully boarded vertical solid infill, providing full privacy, with a contemporary, modern aesthetic.



A (mm)	A (mm)
1600	2500
1700	2600
1800	2700
1900	2800
2000	2900
2100	3000
2200	3250
2300	3500
2400	3750
2500	4000

B (mm)

AVAILABLE AS 1600MM, 1800MM AND 2000MM IN HEIGHT

AGD001PG

Aluminium Garden Gate, flat top, fully boarded vertical solid infill, providing full privacy, with a contemporary, modern aesthetic.



PEDESTRIAN GATE

Design:	Flat Top, Full Privacy, with Vertical Solid Infill
Material:	Aluminium
Opening Direction:	Universal (orientation is set when installing)
Supplied with gate as std:	2 x Adjustable wall mounted hinges, 1 x Floor mounted hinge, 2 x gate handles, 1 x euro barrel lock with 3 x keys, and a full-length lock keep Powder-coated, textured finish
Finish:	Jet Black and Anthracite Grey
Std Gate Colours:	Available as an additional extra. 100mm/100mm/2400mm, 100mm/100mm/ 3000mm and 50mm x 80mm wall mounted
Aluminium Posts & Caps:	
Build:	Fully assembled weather resistant gate

Lock for Manual Operation:	Included as standard
Bespoke:	Gate widths and gate colours are available
Warranty:	Five-year manufacturer's guarantee

COLOUR AVAILABILITY

- **Jet Black** - RAL 9005
- **Anthracite Grey** - RAL 7016
- **Bespoke Colour**

AGD001PG

Aluminium Garden Gate, flat top, fully boarded vertical solid infill, providing full privacy, with a contemporary, modern aesthetic.

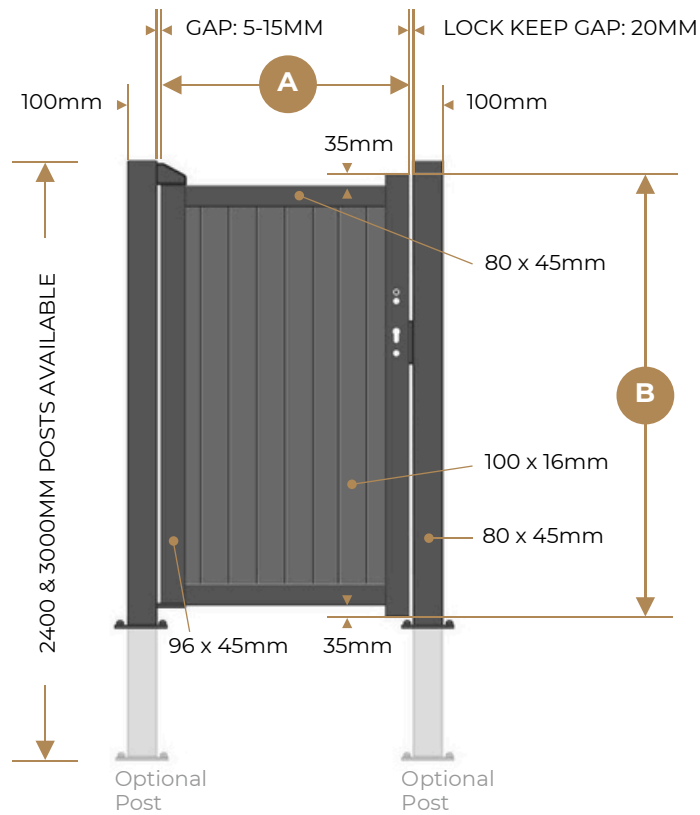

A (mm)	B (mm)
800	1800
850	1800
900	1600
900	1800
900	2000
950	1800
1000	1600
1000	1800
1000	2000
1100	1600
1100	1800

A (mm)	B (mm)
1100	2000
1200	1600
1200	1800
1200	2000
1300	1800
1300	2000
1400	1800
1400	2000
1500	1800
1500	2000

AGD002DG

Aluminium Driveway Gate, flat top, fully boarded horizontal solid infill, providing full privacy, with a contemporary, modern aesthetic.



DOUBLE SWING DRIVEWAY GATE

Design:	Flat Top, Full Privacy, with Horizontal Solid Infill
Material:	Aluminium
Opening Direction:	Universal (orientation is set when installing)
Supplied with gate as std:	4 x Adjustable wall mounted hinges, 2 x Floor mounted hinges
Finish:	Powder-coated, textured finish.
Std Gate Colours:	Jet Black and Anthracite Grey
Aluminium	Available as an additional extra.
Posts & Caps:	150mm/150mm /2400mm and 150mm/150mm/3000mm
Build:	Fully assembled weather resistant gate

Lock for Manual Operation:	Sold separately and factory installed
Bespoke:	Gate widths and gate colours are available
Warranty:	Five-year manufacturer's guarantee

CUSTOMISABLE AS A SLIDING GATE

COLOUR AVAILABILITY

- **Jet Black** - RAL 9005
- **Anthracite Grey** - RAL 7016
- **Bespoke Colour**

AGD002DG

Aluminium Driveway Gate, flat top, fully boarded horizontal solid infill, providing full privacy, with a contemporary, modern aesthetic.

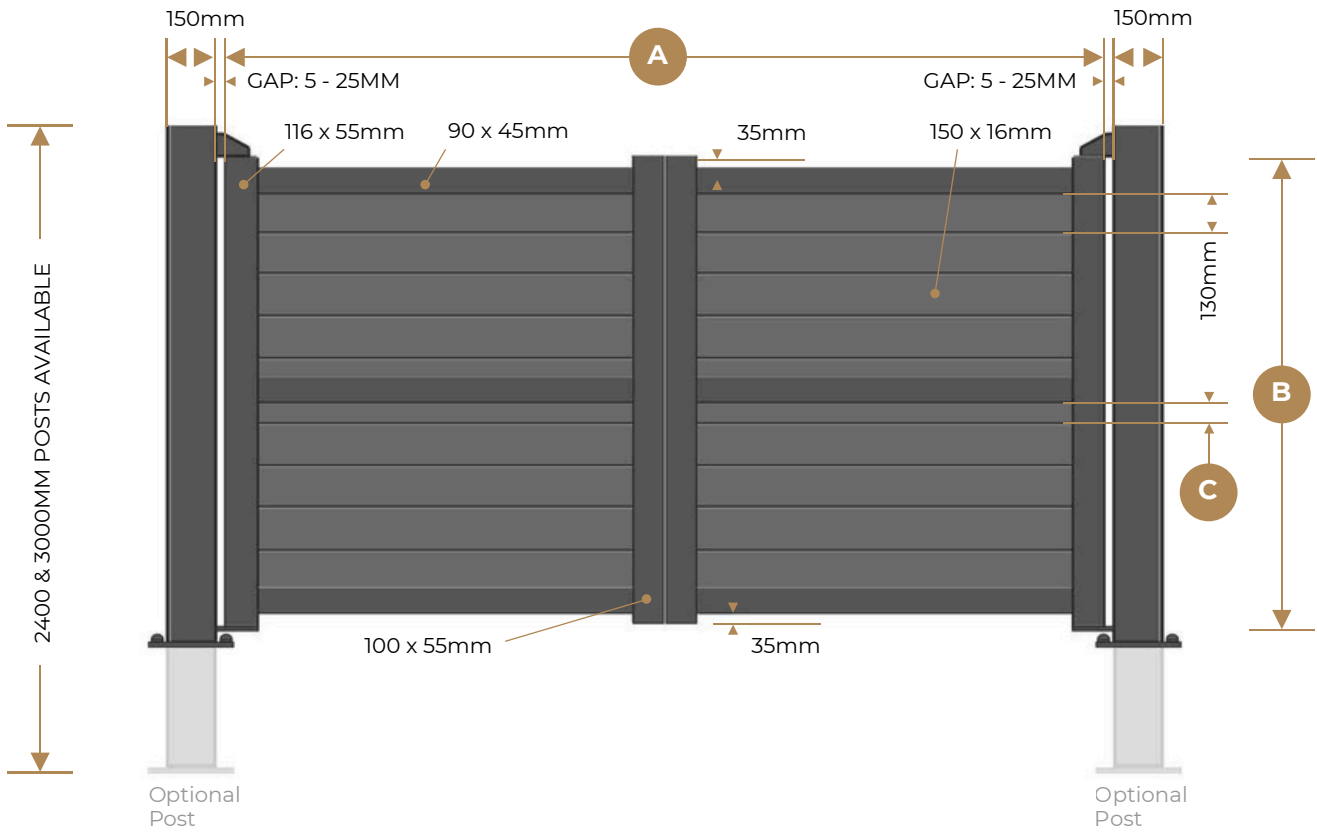

A (mm)	A (mm)
1600	2500
1700	2600
1800	2700
1900	2800
2000	2900
2100	3000
2200	3250
2300	3500
2400	3750
2500	4000

B (mm)

AVAILABLE AS 1600MM, 1800MM AND 2000MM IN HEIGHT

AGD002PG

Aluminium Garden Gate, flat top, fully boarded horizontal solid infill, providing full privacy, with a contemporary, modern aesthetic.



PEDESTRIAN GATE

Design:	Flat Top, Full Privacy, with Horizontal Solid Infill
Material:	Aluminium
Opening Direction:	Universal (orientation is set when installing)
Supplied with gate as std:	2 x Adjustable wall mounted hinges, 1 x Floor mounted hinge, 2 x gate handles, 1 x euro barrel lock with 3 x keys, and a full-length lock keep Powder-coated, textured finish
Finish:	Jet Black and Anthracite Grey
Std Gate Colours:	Available as an additional extra. 100mm/100mm/2400mm, 100mm/100mm/3000mm and 50mm x 80mm wall mounted
Aluminium Posts & Caps:	
Build:	Fully assembled weather resistant gate

Lock for Manual Operation:	Included as standard
Bespoke:	Gate widths and gate colours are available
Warranty:	Five-year manufacturer's guarantee

COLOUR AVAILABILITY

- **Jet Black** - RAL 9005
- **Anthracite Grey** - RAL 7016
- **Bespoke Colour**

AGD002PG

Aluminium Garden Gate, flat top, fully boarded horizontal solid infill, providing full privacy, with a contemporary, modern aesthetic.

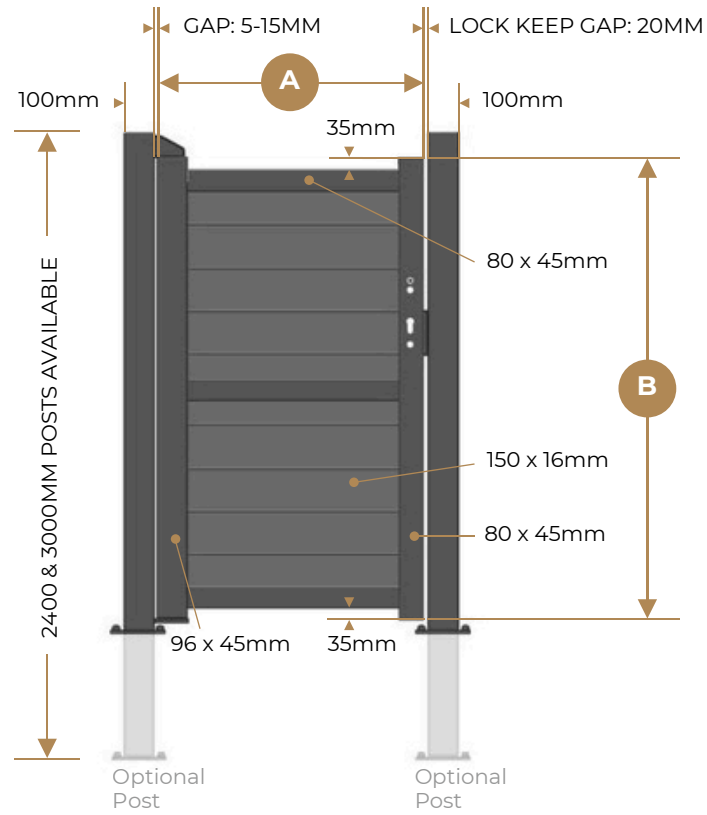

A (mm)	B (mm)
800	1800
850	1800
900	1600
900	1800
900	2000
950	1800
1000	1600
1000	1800
1000	2000
1100	1600
1100	1800

A (mm)	B (mm)
1100	2000
1200	1600
1200	1800
1200	2000
1300	1800
1300	2000
1400	1800
1400	2000
1500	1800
1500	2000

AGD003DG

Aluminium Driveway Gate, flat top, fully boarded diagonal solid infill, providing full privacy, with a contemporary, modern aesthetic.



DOUBLE SWING DRIVEWAY GATE

Design:	Flat Top, Full Privacy, with Diagonal Solid Infill
Material:	Aluminium
Opening Direction:	Universal (orientation is set when installing)
Supplied with gate as std:	4 x Adjustable wall mounted hinges, 2 x Floor mounted hinges
Finish:	Powder-coated, textured finish
Std Gate Colours:	Jet Black and Anthracite Grey
Aluminium	Available as an additional extra.
Posts & Caps:	150mm/150mm /2400mm and 150mm/150mm/3000mm
Build:	Fully assembled weather resistant gate

Lock for Manual Operation:	Sold separately and factory installed
Bespoke:	Gate widths and gate colours are available
Warranty:	Five-year manufacturer's guarantee

CUSTOMISABLE AS A SLIDING GATE

COLOUR AVAILABILITY

- **Jet Black** - RAL 9005
- **Anthracite Grey** - RAL 7016
- **Bespoke Colour**

AGD003DG

Aluminium Driveway Gate, flat top, fully boarded diagonal solid infill, providing full privacy, with a contemporary, modern aesthetic.

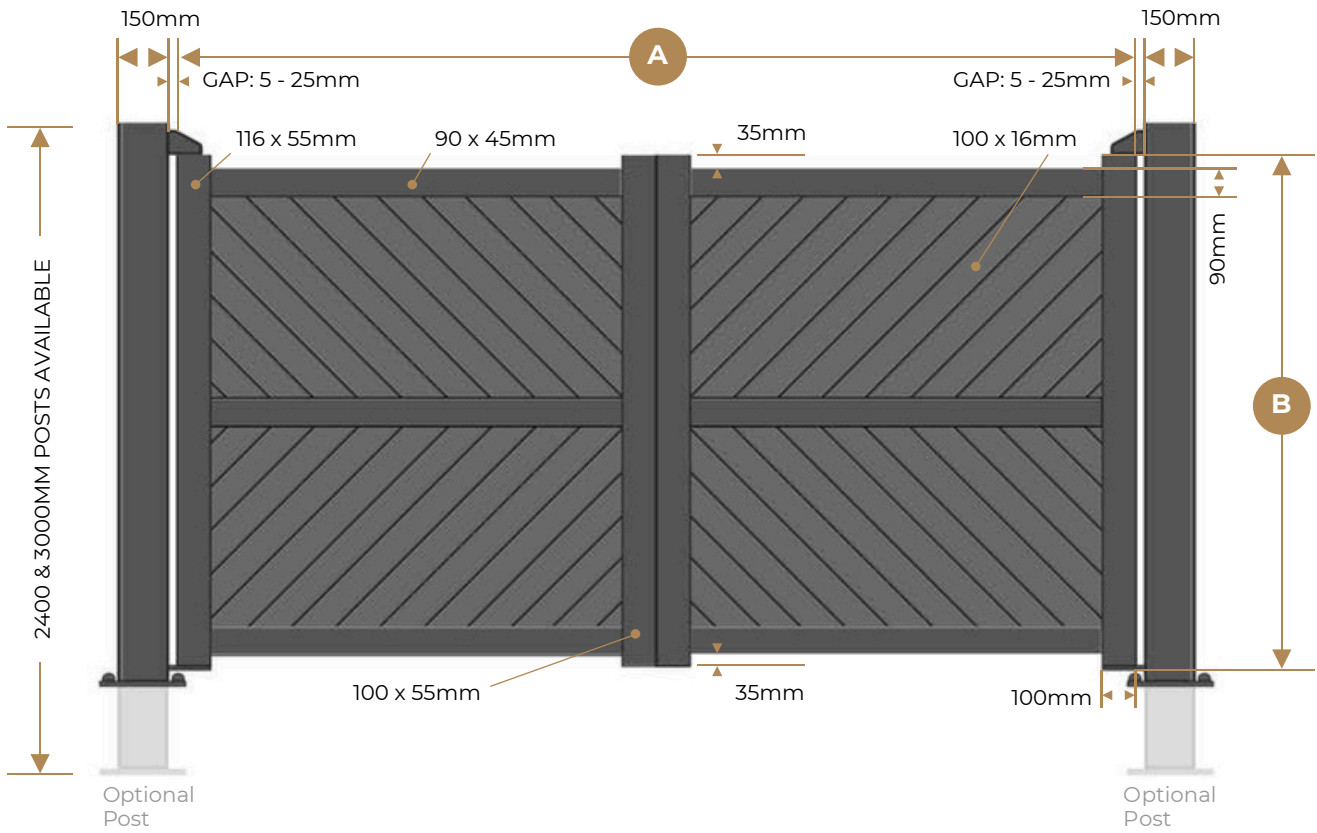

A (mm)	A (mm)
1600	2500
1700	2600
1800	2700
1900	2800
2000	2900
2100	3000
2200	3250
2300	3500
2400	3750
2500	4000

B (mm)

AVAILABLE AS 1600MM, 1800MM AND 2000MM IN HEIGHT

AGD003PG

Aluminium Garden Gate, flat top, fully boarded diagonal solid infill, providing full privacy, with a contemporary, modern aesthetic.



PEDESTRIAN GATE

Design:	Flat Top, Full Privacy, with Diagonal Solid Infill
Material:	Aluminium
Opening Direction:	Universal (orientation is set when installing)
Supplied with gate as std:	2 x Adjustable wall mounted hinges, 1 x Floor mounted hinge, 2 x gate handles, 1 x euro barrel lock with 3 x keys, and a full-length lock keep Powder-coated, textured finish
Finish:	Jet Black and Anthracite Grey
Std Gate Colours:	Available as an additional extra. 100mm/100mm/2400mm, 100mm/100mm/3000mm and 50mm x 80mm wall mounted
Aluminium Posts & Caps:	
Build:	Fully assembled weather resistant gate

Lock for Manual Operation:	Included as standard
Bespoke:	Gate widths and gate colours are available
Warranty:	Five-year manufacturer's guarantee

COLOUR AVAILABILITY

- **Jet Black** - RAL 9005
- **Anthracite Grey** - RAL 7016
- **Bespoke Colour**

AGD003PG

Aluminium Garden Gate, flat top, fully boarded diagonal solid infill, providing full privacy, with a contemporary, modern aesthetic.

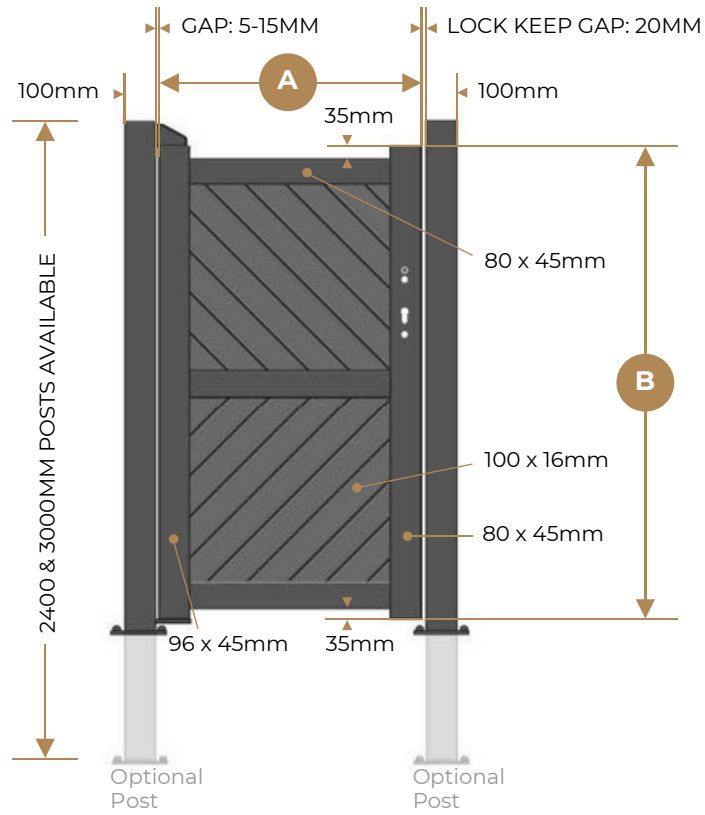

A (mm)	B (mm)
800	1800
850	1800
900	1600
900	1800
900	2000
950	1800
1000	1600
1000	1800
1000	2000
1100	1600
1100	1800

A (mm)	B (mm)
1100	2000
1200	1600
1200	1800
1200	2000
1300	1800
1300	2000
1400	1800
1400	2000
1500	1800
1500	2000

AGD004DG

Aluminium Driveway Gate, bell-curved top, fully boarded vertical solid infill, providing full privacy, with a contemporary, modern aesthetic.



DOUBLE SWING DRIVEWAY GATE

Design:	Bell-Curved Top, Full Privacy, with Vertical Solid Infill
Material:	Aluminium
Opening Direction:	Universal (orientation is set when installing)
Supplied with gate as std:	4 x Adjustable wall mounted hinges, 2 x Floor mounted hinges
Finish:	Powder-coated, textured finish
Std Gate Colours:	Jet Black and Anthracite Grey
Aluminium	Available as an additional extra.
Posts & Caps:	150mm/150mm /2400mm and 150mm/150mm/3000mm
Build:	Fully assembled weather resistant gate

Lock for Manual Operation:	Sold separately and factory installed
Bespoke:	Gate widths and gate colours are available
Warranty:	Five-year manufacturer's guarantee

CUSTOMISABLE AS A SLIDING GATE

COLOUR AVAILABILITY

- **Jet Black** - RAL 9005
- **Anthracite Grey** - RAL 7016
- **Bespoke Colour**

AGD004DG

Aluminium Driveway Gate, bell-curved top, fully boarded vertical solid infill, providing full privacy, with a contemporary, modern aesthetic.

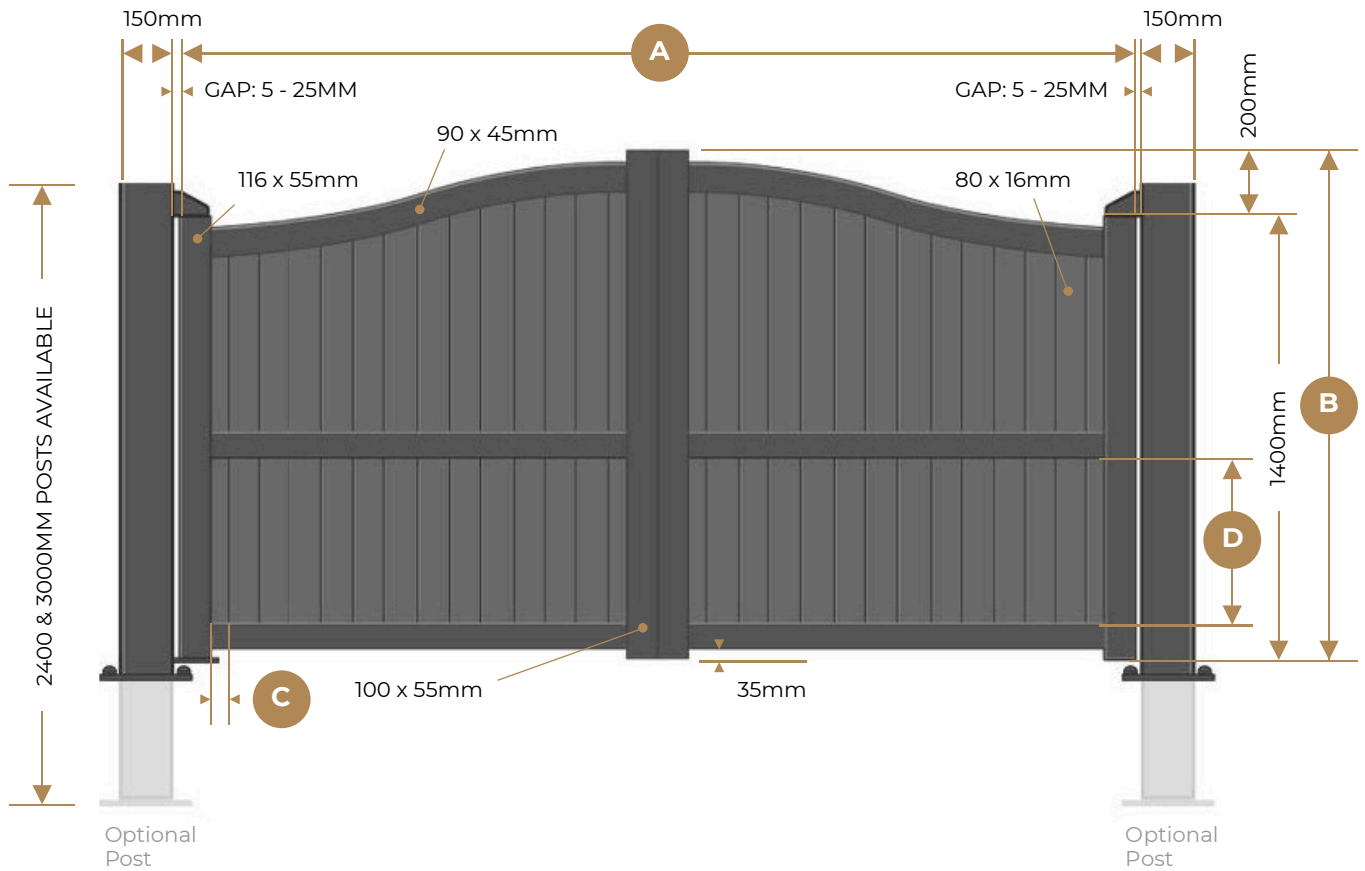

A (mm)	B (mm)	C (mm)	D (mm)
3000	1600	50	500
3000	1800	50	500
3000	2000	50	700
3250	1600	63	500
3250	1800	63	500
3250	2000	63	700
3500	1600	75	500
3500	1800	75	500
3500	2000	75	700
3750	1600	38	500
3750	1800	38	500
3750	2000	38	700
4000	1600	50	500
4000	1800	50	500
4000	2000	50	700

AGD005DG

Aluminium Driveway Gate, bell-curved top, partial privacy vertical mixed infill, providing partial privacy, with unique style for visibility at the top.



DOUBLE SWING DRIVEWAY GATE

Design:	Bell-curved top, Partial Privacy, with Vertical Mixed Infill
Material:	Aluminium
Opening Direction:	Universal (orientation is set when installing)
Supplied with gate as std:	4 x Adjustable wall mounted hinges, 2 x Floor mounted hinges
Finish:	Powder-coated, textured finish
Std Gate Colours:	Jet Black and Anthracite Grey
Aluminium	Available as an additional extra.
Posts & Caps:	150mm/150mm /2400mm and 150mm/150mm/3000mm
Build:	Fully assembled weather resistant gate

Lock for Manual Operation:	Sold separately and factory installed
Bespoke:	Gate widths and gate colours are available
Warranty:	Five-year manufacturer's guarantee

CUSTOMISABLE AS A SLIDING GATE

COLOUR AVAILABILITY

- **Jet Black** - RAL 9005
- **Anthracite Grey** - RAL 7016
- **Bespoke Colour**

AGD005DG

Aluminium Driveway Gate, bell-curved top, partial privacy vertical mixed infill, providing partial privacy, with unique style for visibility at the top.



A (mm)	B (mm)	C (mm)	D (mm)
3000	1600	50	280
3000	1800	50	280
3000	2000	50	350
3250	1600	63	280
3250	1800	63	280
3250	2000	63	350
3500	1600	75	280
3500	1800	75	280
3500	2000	75	350
3750	1600	88	280
3750	1800	88	280
3750	2000	88	350
4000	1600	50	280
4000	1800	50	280
4000	2000	50	350

AGD006DG

Aluminium Driveway Gate, flat top, with partial privacy, and vertical mixed infill for visibility at the top of the gate, a contemporary modern aesthetic.



DOUBLE SWING DRIVEWAY GATE

Design:	Flat Top, Partial Privacy, with Vertical Mixed Infill
Material:	Aluminium
Opening Direction:	Universal (orientation is set when installing)
Supplied with gate as std:	4 x Adjustable wall mounted hinges, 2 x Floor mounted hinges
Finish:	Powder-coated, textured finish
Std Gate Colours:	Jet Black and Anthracite Grey
Aluminium	Available as an additional extra.
Posts & Caps:	150mm/150mm /2400mm and 150mm/150mm/3000mm
Build:	Fully assembled weather resistant gate

Lock for Manual Operation:	Sold separately and factory installed
Bespoke:	Gate widths and gate colours are available
Warranty:	Five-year manufacturer's guarantee

CUSTOMISABLE AS A SLIDING GATE

COLOUR AVAILABILITY

- **Jet Black** - RAL 9005
- **Anthracite Grey** - RAL 7016
- **Bespoke Colour**

AGD006PG

Aluminium Garden Gate, flat top, partial privacy vertical mixed infill, with a contemporary, modern aesthetic.



PEDESTRIAN GATE

Design: Flat Top, Partial Privacy, with Vertical Mixed Infill

Material: Aluminium

Opening Direction: Universal (orientation is set when installing)

Supplied with gate as std: 2 x Adjustable wall mounted hinges, 1 x Floor mounted hinge, 2 x gate handles, 1 x euro barrel lock with 3 x keys, and a full-length lock keep

Finish: Powder-coated, textured finish

Std Gate Colours: Jet Black and Anthracite Grey

Aluminium Posts & Caps: Available as an additional extra. 100mm/100mm/2400mm, 100mm/100mm/3000mm and 50mm x 80mm wall mounted Fully assembled weather resistant gate

Build:

Lock for Manual Operation: Included as standard

Bespoke: Gate widths and gate colours are available

Warranty: Five-year manufacturer's guarantee

COLOUR AVAILABILITY

- **Jet Black** - RAL 9005
- **Anthracite Grey** - RAL 7016
- **Bespoke Colour**

AGD006PG

Aluminium Garden Gate, flat top, partial privacy vertical mixed infill, with a contemporary, modern aesthetic.

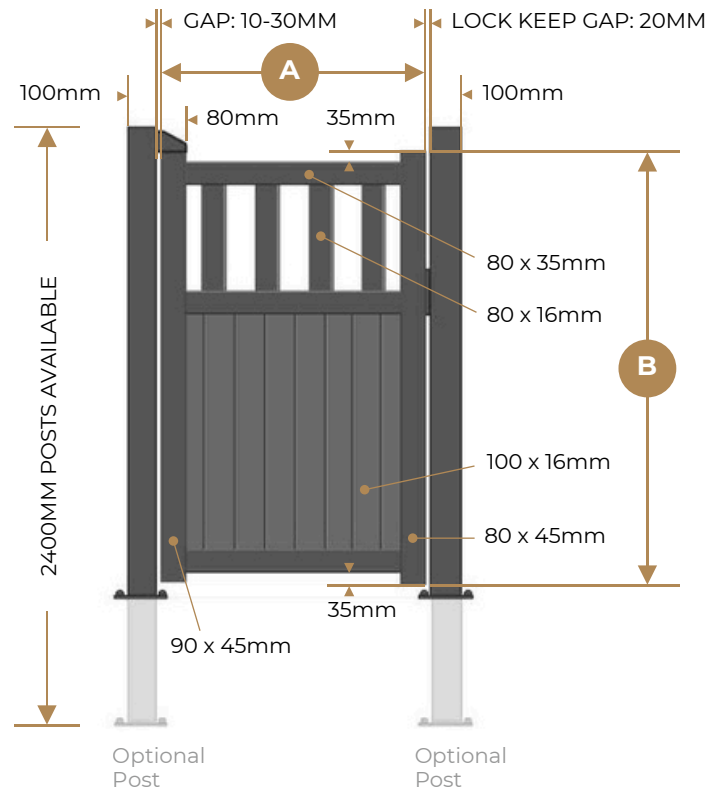

A (mm)	B (mm)
900	1000
900	1200
900	1400
900	1600
900	1800
900	2000
1000	1000
1000	1200
1000	1400
1000	1600
1000	1800
1000	2000

A (mm)	B (mm)
1100	1000
1100	1200
1100	1400
1100	1600
1100	1800
1100	2000
1200	1000
1200	1200
1200	1400
1200	1600
1200	1800
1200	2000

AGD007DG

Aluminium Driveway Gate, bell-curved top, with partial privacy, and vertical mixed infill for visibility at the top of the gate, a contemporary modern aesthetic.



DOUBLE SWING DRIVEWAY GATE

Design:	Bell-curved top, Partial Privacy, with Vertical Mixed Infill
Material:	Aluminium
Opening Direction:	Universal (orientation is set when installing)
Supplied with gate as std:	4 x Adjustable wall mounted hinges, 2 x Floor mounted hinges
Finish:	Powder-coated, textured finish
Std Gate Colours:	Jet Black and Anthracite Grey
Aluminium	Available as an additional extra.
Posts & Caps:	150mm/150mm /2400mm and 150mm/150mm/3000mm
Build:	Fully assembled weather resistant gate

Lock for Manual Operation:	Sold separately and factory installed
Bespoke:	Gate widths and gate colours are available
Warranty:	Five-year manufacturer's guarantee

CUSTOMISABLE AS A SLIDING GATE

COLOUR AVAILABILITY

- **Jet Black** - RAL 9005
- **Anthracite Grey** - RAL 7016
- **Bespoke Colour**

AGD007DG

Aluminium Driveway Gate, bell-curved top, with partial privacy, and vertical mixed infill for visibility at the top of the gate, a contemporary modern aesthetic.



A (mm)	B (mm)	C (mm)
3000	1600	50
3000	1800	50
3000	2000	50
3250	1600	63
3250	1800	63
3250	2000	63
3500	1600	75
3500	1800	75
3500	2000	75
3750	1600	38
3750	1800	38
3750	2000	38
4000	1600	50
4000	1800	50
4000	2000	50

AGD008DG

Aluminium Driveway Gate, bell-curved top, partial privacy vertical mixed infill, providing partial privacy, and a thicker more robust style, and visibility on top.



DOUBLE SWING DRIVEWAY GATE - EXECUTIVE

Design:	Bell-curved top, Partial Privacy, with Vertical Mixed Infill
Material:	Aluminium
Opening Direction:	Universal (orientation is set when installing)
Hinges:	Custom Hinges available as additional extras. Top pair, bottom pair or both.
Finish:	Powder-coated, textured finish
Std Gate Colours:	Jet Black
Aluminium Posts & Caps:	Available as an additional extra. 150mm/150mm /2400mm and 150mm/150mm/3000mm
Build:	Fully assembled weather resistant gate

Lock for Manual Operation:	Sold separately and factory installed
Bespoke:	Gate widths and gate colours are available
Warranty:	Five-year manufacturer's guarantee

CUSTOMISABLE AS A SLIDING GATE

COLOUR AVAILABILITY

- Jet Black - RAL 9005
- Bespoke Colour

AGD008DG

Aluminium Driveway Gate, bell-curved top, partial privacy vertical mixed infill, providing partial privacy, and a thicker more robust style, and visibility on top.

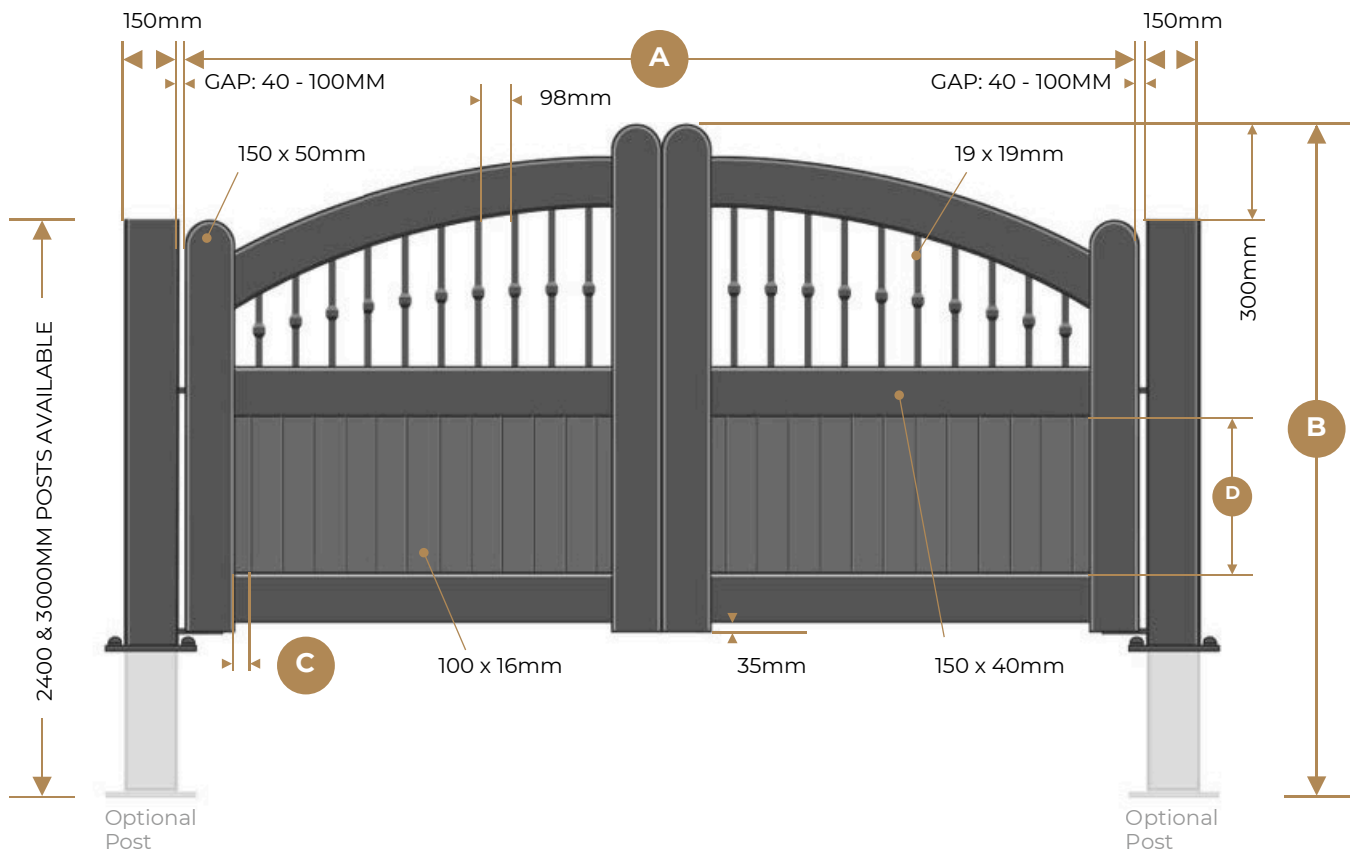

A (mm)	B (mm)	C (mm)	D (mm)
3500	1800	75	500
3500	2000	75	700
3750	1800	38	500
3750	2000	38	700
4000	1800	50	500
4250	1800	63	500
4250	2000	63	700
4500	1800	75	500
4500	2000	75	700

AGD009DG

Aluminium Wood Effect Driveway Gate, bell-curved top, vertical mixed infill, for partial privacy, and a thicker robust style with visibility at the top.



DOUBLE SWING DRIVEWAY GATE - EXECUTIVE

Design:	Bell-curved top, Partial Privacy, with Vertical Mixed Infill
Material:	Aluminium (Wood Effect)
Opening Direction:	Universal (orientation is set when installing)
Hinges:	Custom Hinges available as additional extras. Top pair, bottom pair or both.
Finish:	Powder-coated, textured finish
Std Gate Colours:	Wood Effect (Light Oak)
Aluminium Posts & Caps:	Available as an additional extra. 150mm/150mm /2400mm and 150mm/150mm/3000mm
Build:	Fully assembled weather resistant gate

Lock for Manual Operation:	Sold separately and factory installed
Bespoke:	Gate widths and gate colours are available
Warranty:	Five-year manufacturer's guarantee

CUSTOMISABLE AS A SLIDING GATE

COLOUR AVAILABILITY

- Wood Effect - Light Oak

AGD009DG

Aluminium Wood Effect Driveway Gate, bell-curved top, vertical mixed infill, for partial privacy, and a thicker robust style with visibility at the top.

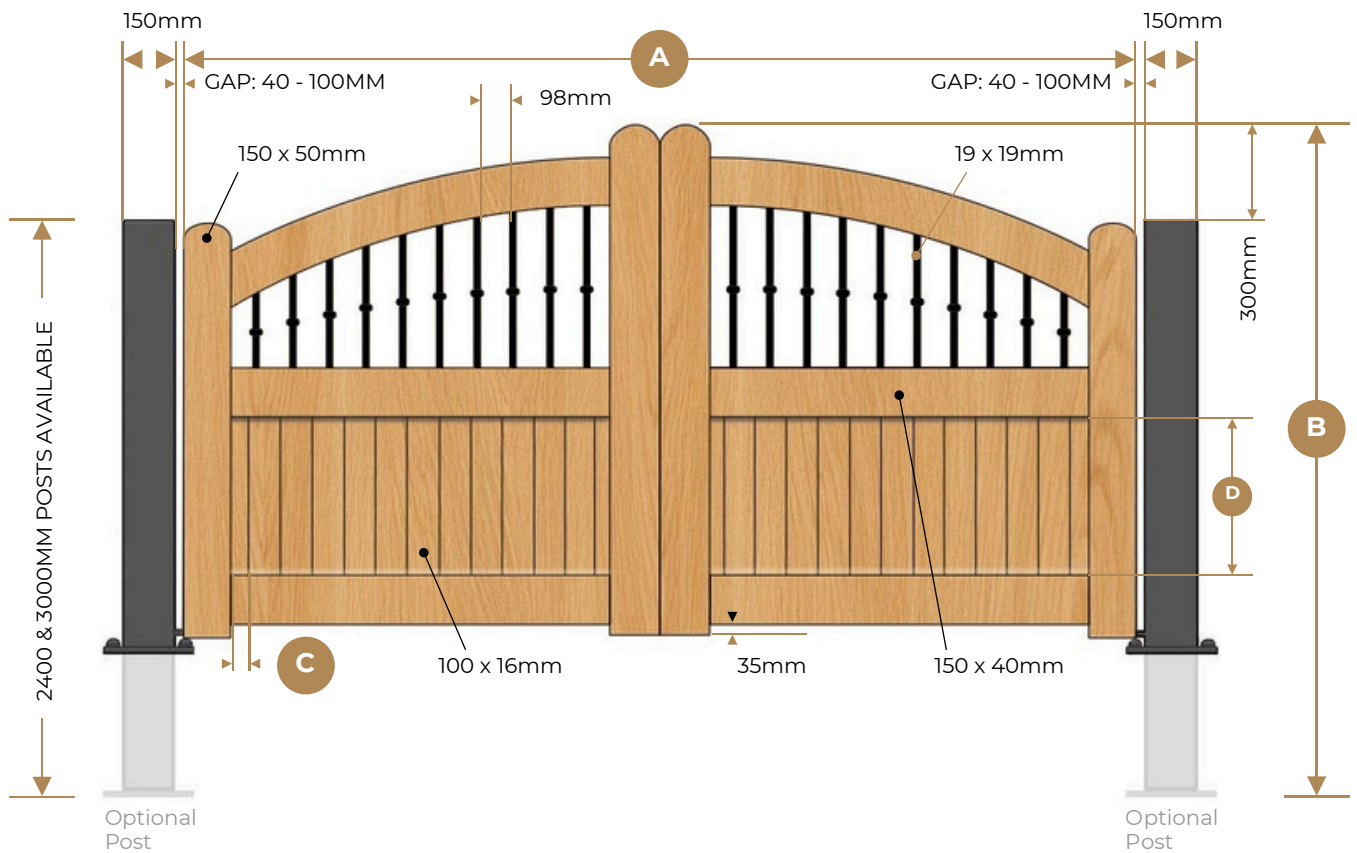

A (mm)	B (mm)	C (mm)	D (mm)
3500	1800	75	500
3500	2000	75	700
3750	1800	38	500
3750	2000	38	700
4000	1800	50	500
4250	1800	63	500
4250	2000	63	700
4500	1800	75	500
4500	2000	75	700

AGD010DG

Aluminium Driveway Gate, flat top, partial privacy vertical mixed infill, providing partial privacy, with unique style for visibility at the top.



DOUBLE SWING DRIVEWAY GATE

Design:	Flat Top, Partial Privacy, with Vertical Mixed Infill
Material:	Aluminium
Opening Direction:	Universal (orientation is set when installing)
Supplied with gate as std:	4 x Adjustable wall mounted hinges, 2 x Floor mounted hinges
Finish:	Powder-coated, textured finish
Std Gate Colours:	Jet Black
Aluminium	Available as an additional extra.
Posts & Caps:	150mm/150mm /2400mm and 150mm/150mm/3000mm
Build:	Fully assembled weather resistant gate

Lock for Manual Operation:	Sold seperately and factory installed
Bespoke:	Gate widths and gate colours are available
Warranty:	Five-year manufacturer's guarantee

CUSTOMISABLE AS A SLIDING GATE

COLOUR AVAILABILITY

- Jet Black - RAL 9005
- Bespoke Colour

AGD010DG

Aluminium Driveway Gate, flat top, partial privacy vertical mixed infill, providing partial privacy, with unique style for visibility at the top.



A (mm)	B (mm)
3000	1600
3000	1800
3000	2000
3250	1600
3250	1800
3250	2000
3500	1600
3500	1800
3500	2000
3750	1600
3750	1800

A (mm)	B (mm)
3750	2000
4000	1600
4000	1800
4000	2000
4250	1600
4250	1800
4250	2000
4500	1600
4500	1800
4500	2000

SLIDING GATES

We specialise in crafting fully customisable aluminium sliding gates designed to meet your customers' exact requirements - with no hidden extras.

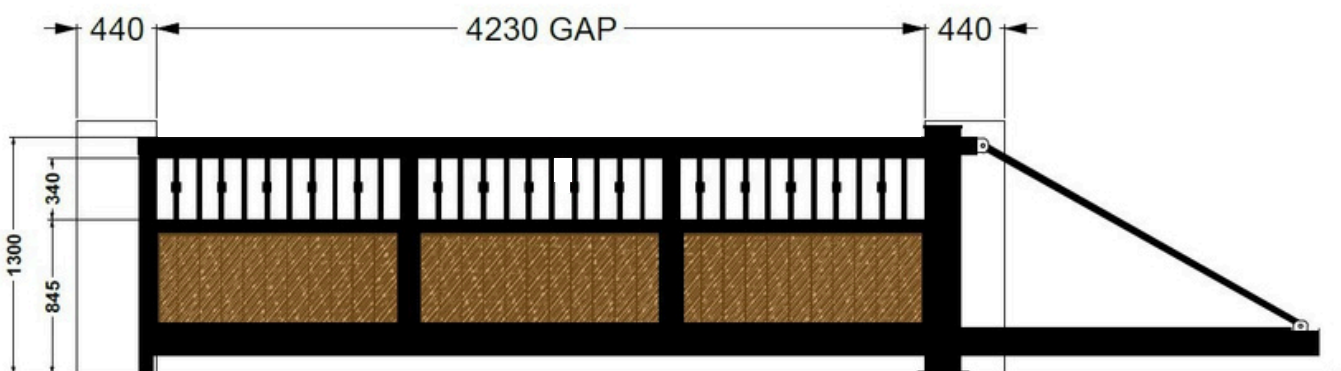

Drawing Provided for Installation Reference

SLIDING GATES

We specialise in crafting fully customisable aluminium sliding gates designed to meet your customers' exact requirements - with no hidden extras.

The Aluminium Sliding Gate - a harmonious blend of modern aesthetics and cutting-edge engineering designed to elevate both the security and visual appeal of your property.

Sleek Integration with Advanced Technology

Our cantilever gate features a main tower post that seamlessly houses the Roger Technology motor and gearbox. This internal integration eliminates visible mechanical components, resulting in a clean and streamlined appearance that enhances the gate's contemporary design.

Innovative Concealed Mechanisms

The gate's aluminium extruded lower beam is meticulously crafted to discreetly enclose the nylon racking system. Unlike conventional designs where racking is exposed on the beam's side, our approach ensures a more aesthetically pleasing profile without compromising functionality.

Versatile Design Options

- **Cantilever Sliding Gates:** Ideal for uneven terrains or areas where ground tracks are impractical.
- **Tracked Sliding Gates:** Suitable for installations where ground conditions permit track laying.
- **Convertible Double Swing Gates:** Our double swing gate designs can be seamlessly adapted into sliding gates, providing over twenty distinct design options to cater to various architectural preferences.

Key Features and Benefits

- **Enhanced Aesthetics:** Concealed mechanical components contribute to a sleek and modern look.
- **Space Efficiency:** Sliding mechanisms require less operational space compared to traditional swing gates.
- **Customisation:** A wide range of designs ensures a perfect match for your property's style.
- **Durability:** High-quality aluminium construction offers longevity and resistance to environmental factors.

ALUMINIUM CANTILEVER GATES

We specialise in crafting fully customisable aluminium cantilever gates designed to meet your customers' exact requirements - with no hidden extras.



ALUMINIUM CANTILEVER GATES

We specialise in crafting fully customisable aluminium cantilever gates designed to meet your customers' exact requirements - with no hidden extras.

Key Features of Our Cantilever Gates:

Robust Warranties:

- 3-Year Warranty on Mechanical and Electrical Components
- 5-Year Warranty on Aluminium Gate Structure

Infills Options:

- Louvre
- Open Board
- Semi-Open Board
- Fully Boarded (Horizontal or Vertical)

Flexible Sizing Options:

- Up to 5.5 metres wide and 2.0 metres high with a 45-degree tension bar
- Up to 5.0 metres wide and 2.0 metres high with a complete board frame

Operational Versatility:

- Available as Manual or Fully Automated systems

Diverse Aesthetic Choices:

- Standard colors include Black, Anthracite Grey, and Wood Effect Infill
- Additional colors available upon request

Efficient Installation Process:

- Our sliding gates are pre-assembled, tested, and delivered to your site via our own hi-ab vehicles, ensuring a genuine "Plug & Play" installation experience

Advanced Automation Technology:

- Integrated Roger Technology Brushless Motor/Gearbox for super-intensive use
- Encoder-controlled for precision, eliminating the need for limit switches or strikers
- Equipped with dual sets of hard-wired photo cells for enhanced safety
- Features integrated nylon gear racking with a steel core, discreetly housed within our proprietary aluminium beam design

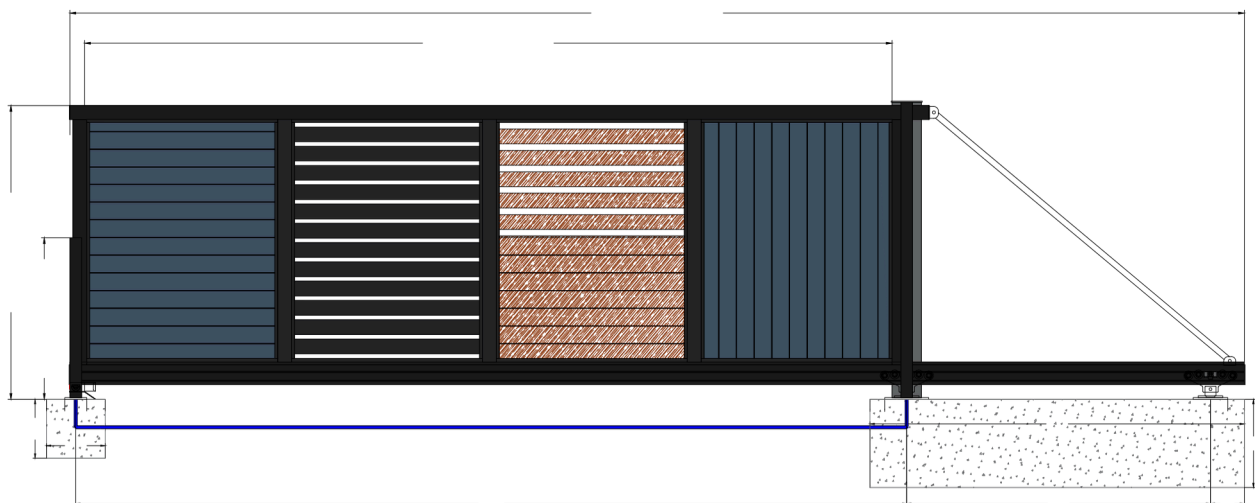

ALUMINIUM TRACKED GATES

We specialise in crafting fully customisable aluminium tracked gates designed to meet your customers' exact requirements - with no hidden extras.



ALUMINIUM TRACKED GATES

We specialise in crafting fully customisable aluminium tracked gates designed to meet your customers' exact requirements - with no hidden extras.

Key Features of Our Tracked Sliding Gates:

Robust Warranties:

- 3-Year Warranty on Mechanical and Electrical Components
- 5-Year Warranty on Aluminium Gate Structure

Flexible Sizing Options:

- Up to 5.5 metres wide and 2.0 metres high with a complete board frame

Diverse Aesthetic Choices:

- Standard colours include Black, Anthracite Grey
- Additional colors available upon request

Efficient Installation Process:

- Our sliding gates are pre-assembled, tested, and delivered to your site via our own hi-ab vehicles, ensuring a genuine "Plug & Play" installation experience

Infills Options:

- Louvre
- Fully Boarded (Horizontal or Vertical)

Operational Versatility:

- Available as Manual or Fully Automated systems

Advanced Automation Technology:

- Integrated Roger Technology Brushless Motor/Gearbox for super-intensive use
- Encoder-controlled for precision, eliminating the need for limit switches or strikers
- Equipped with dual sets of hard-wired photo cells for enhanced safety
- Features integrated nylon gear racking with a steel core, discreetly housed within our proprietary aluminium beam design

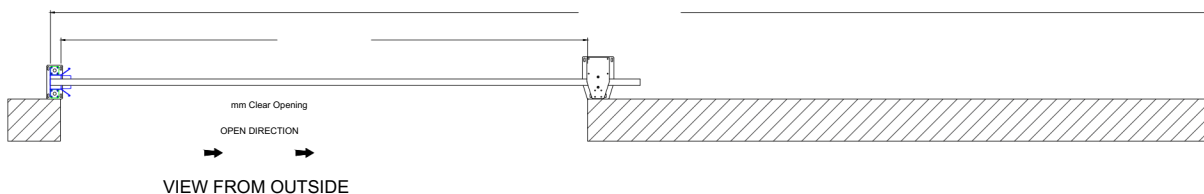
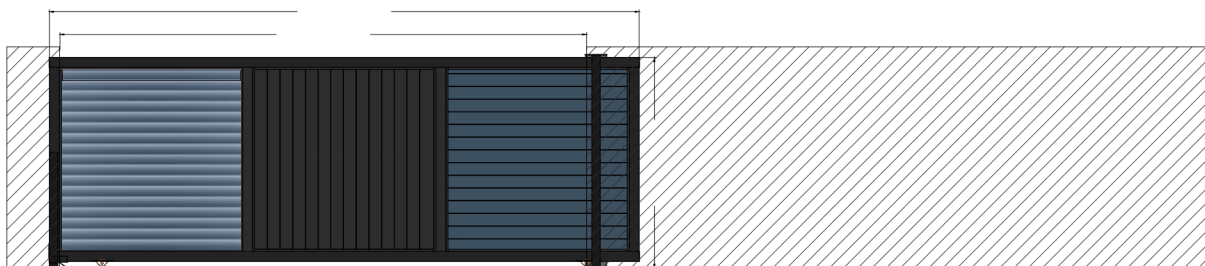

ALUMINIUM POSTS

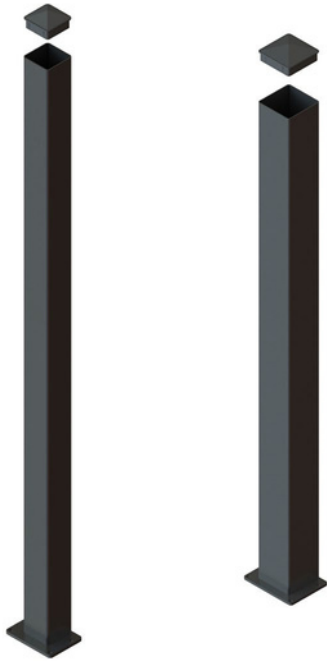

ALUMINIUM POSTS

Posts combine strength with a lightweight design - ideal for both residential and commercial applications.

- Constructed from 3.5mm wall aluminium (or 5mm wall thickness for Heavy Duty options)
- Supplied with a pyramid-style post cap as standard
- Features a three-sided welded baseplate for a secure, tight fit against walls
- Versatile installation – can be bolted down with included fixings or buried and concreted into place

100/100/3.5/2400mm	150/150/3.5/3000mm
100/100/3.5/3000mm	150/150/5/2400mm
150/150/3.5/2400mm	150/150/5/3000mm

Colours available: Black / Anthracite Grey / Wood Effect

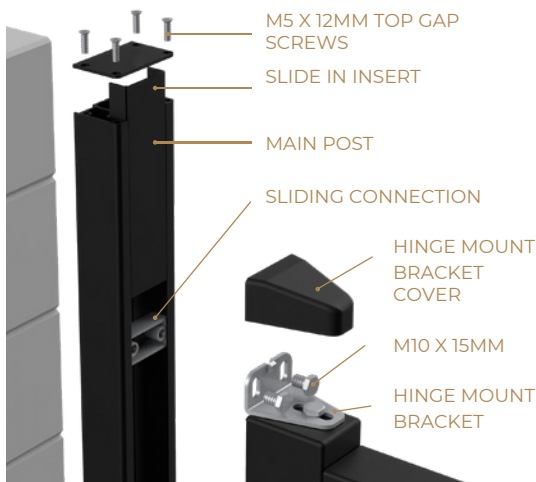

WALL MOUNTED POSTS

Our wall mounted pedestrian gate posts have been designed with the installer in mind.

These come with easy to fix hinge points built in and are available in either 2000mm or 2400mm lengths. The removable base plate allows for firm fixing to a solid base and the built-in access points allow for multiple wall fixings to make the installation more secure.

The receiver post has the same fixing options and comes with a full-length lock keep which inserts into the post for extra privacy.

Colours available: Black / Anthracite Grey

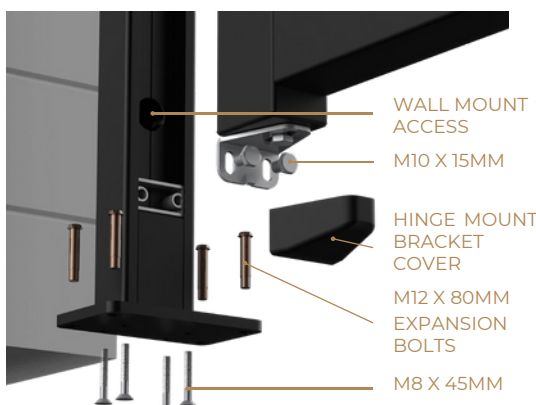

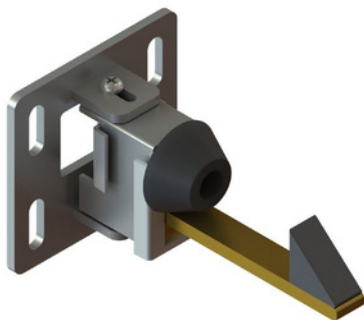

PEDESTRIAN GATE STOP

AGDA-01

- Custom-designed for pedestrian gates
- Holds the gate in an open position
- Foot-operated arm for easy release when closing



REAR MOUNTED HINGE

AGDA-02

- Optional hinge for gates mounted on the rear of a brick pier or posts
- Allows for lateral adjustment, simplifying installation

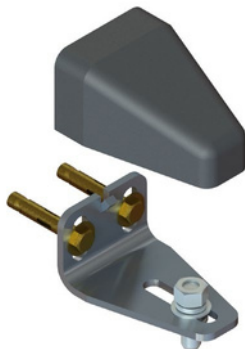

ADJUSTABLE HINGES

AGDA-03 (DG) / AGDA-07 (PG)

- Supplied as standard with all gates
- Adjustable for easy fitting between brickwork or posts



FLOOR MOUNTED HINGE

AGDA-04

- Supplied as standard with all gates
- Designed for use with aluminium posts
- Provides additional support when a wall-mounted hinge isn't an option



GATE LOCK AND HANDLE SET

AGDA-05 (DG) / AGDA-09 (PG)

- RMGA-09 comes standard for pedestrian gates, ensuring secure locking
- RMGA-05 can be added to double gates as an optional manual locking system



GATE STOP

AGDA-06

- Designed for double gates
- Prevents gates from swinging past their stop position
- Works with gates fitted with a lock and handle; the adjustable arm can be removed for automatic gates



LOCINOX KEYDROP

AGDL01/02 A lockable drop bolt that can be secured in both the open and closed positions. Available in black and anthracite grey, offering enhanced security for manually operated gates



LOCINOX ALUMINIUM GATE HOLD-BACK CATCH

AGDL05 Durable aluminium gate catcher with an adjustable and reversible hook. Features a rubber stop and polyamide catch to protect the gate frame. Designed for fast and secure fixing in concrete.

OPTIONAL EXTRAS



LOCINOX BOLT-ON OFF-CENTRED GROUND STOP

AGDL06 Robust surface-mounted ground stop for

double-wing gates. Suitable for drop bolts with a maximum diameter of 20mm.



B-SAFE STAINLESS STEEL SAFETY CABLE

AGDA-02 Prevents gate collapse in the event of hinge

failure.

Patented Quick-Fix system allows secure installation into the gate post. Rated for gates up to 500 kg, with a load capacity of 1000 kg.



DIGITAL SMART LOCK

KEYPAD

Ruveno Slim Smart Fingerprint Lock with handles. Offers multiple keyless entry options including Bluetooth, fingerprint, keypad, card, and manual key. Designed for aluminium gates.



**ALUMINIUM GATES
WALES**



enquiries@aluminiumgateswales.co.uk

aluminiumgateswales.co.uk

0114 3521525